



# ORIENTE e NIPPO

## PANEL TRACK SYSTEMS





# ORIENTE

## UNA GAMMA COMPLETA

Oriente è il programma di sistemi per tende a pannelli, l'ultima generazione di una linea di prodotto da sempre presente nell'offerta di sistemi tecnologici di Mottura. Funzionalità e qualità, come sempre, le priorità nei sistemi tecnologici Mottura.

La gamma è:

Oriente 542 - sistema a 2 vie.

Oriente 543 - sistema a 3 vie.

Oriente 544 - sistema a 4 vie.

Oriente 545 - sistema a 5 vie.

ORIENTE 542

## A FULL RANGE

Oriente is the panels track systems program, the latest generation of a product line which has always been present in Mottura technological systems' offer.

Functionality and quality, as always, the priorities in Mottura technological systems.

The offered range is:

Oriente 542 - 2 ways system

Oriente 543 - 3 ways system

Oriente 544 - 4 ways system

Oriente 545 - 5 ways system

ORIENTE 543

## LE QUALITÀ

Silenziosità e scorrevolezza come risultato di una tecnologia sofisticata per garantire una prestazione ed una longevità superiori.

## QUALITY

Mottura main priority is quality, with our sophisticated technology we can produce quiet and smooth running Panel track systems and guarantee excellent performance and longevity.

ORIENTE 544

## GLI AZIONAMENTI

Oriente offre ogni soluzione in termini di azionamento:

**Azionamento manuale a pannelli liberi** - I teli vengono posizionati manualmente e sono sovrapponibili in qualsiasi posizione per tutta la superficie che si intende arredare con il sistema.

**Azionamento manuale con asta di comando** - I teli sono agganciati l'uno all'altro in modo tale che il movimento di uno di essi provochi anche lo spostamento degli altri.

**Azionamento a corde** - I teli sono, anche in questo caso, agganciati l'uno all'altro ma l'azionamento di essi è a corda. È una soluzione consigliabile per tutti i tessuti delicati.

**Azionamento a motore** - Oriente permette l'utilizzo in parallelo con Power 401 o Power 571 sia azionamento a pulsante che wireless con comando radio R.F. M2net.

## OPERATING

Oriente offers every solution in terms of actuation:

**Not-hooked hand drawn panels** - The fabric panels are manually placed and are stackable in any position for the entire surface that you desire to decorate with the system.

**Manual operation with control rod** - The curtains are attached one to the other, in such a way that the movement of one of them also causes the displacement of the other.

**Drive to ropes** - The panels are, also in this case, hooked one to another but the operating is with cord. It is a advisable solution for all of the delicate fabrics.

**Motorized** - Oriente can be used in parallel with Power 401/571 both by press switch and wireless with M2net solutions.

## I COLORI

Oriente è disponibile di serie nelle seguenti varianti colori: laccato bianco, laccato nero e anodizzato argento. È fornibile, su richiesta, a colore speciale.

## COLOURS

Oriente is, as standard, available in the following colours: white laqued, black laqued and silver anodized. It is available, on demand, in special colours.

ORIENTE 545

# NIPPO

Design e qualità le priorità di Nippo, la gamma di sistemi per tende a pannelli più particolare e nuova rivolta al mondo dell'interior design.

Design and quality are priorities of Nippo, the range of systems for japanese panels more exclusive and new, faced to the world of interior design.



NIPPO 642

## LA GAMMA

Nippo offre quattro sistemi per arredare spazi diversi:

NIPPO 642 – sistema a 2 vie

NIPPO 643 – sistema a 3 vie

NIPPO 644 – sistema a 4 vie

NIPPO 645 – sistema a 5 vie

## THE RANGE

Nippo range offers four ways to furnish different spaces:

NIPPO 642 - 2 ways system

NIPPO 643 - 3 ways system

NIPPO 644 - 4 ways system

NIPPO 645 - 5 ways system



NIPPO 643

## GLI AZIONAMENTI

La gamma Nippo adotta due tipologie di azionamento:

**Azionamento manuale a pannelli liberi** - I teli vengono posizionati manualmente e sono sovrapponibili in qualsiasi posizione per tutta la superficie che si intende arredare con il sistema.

**Azionamento manuale con asta di comando** - I teli sono agganciati l'uno all'altro in modo tale che il movimento di uno di essi provochi anche lo spostamento degli altri.

## OPERATING

Nippo offers two solutions in terms of actuation:

**Not-hooked hand drawn panels** - The fabric panels are manually placed and are stackable in any position for the entire surface that you desire to decorate with the system.

**Manual operation with control rod** - The curtains are attached to one another in such a way that the movement of one of them also causes the displacement of the other.



NIPPO 644

## LA CURA PER IL DETTAGLIO

Una estrema attenzione all'utilizzo di materiali pregiati per evidenziare il valore aggiunto di un prodotto fuori dal coro. Nippo è la sinergia tra estetica e qualità, la massima accuratezza nei dettagli e la tecnologia di chi produce da cinquant'anni sistemi per tende destinati agli specialisti di tutto il mondo.

## FOCUSED ON DETAILS

An extreme attention to the use of fine materials to highlight the added value of a particular product. Nippo is the result of the synergy between aesthetics and quality, the maximum accuracy in the details and the technology of who has been producing for fifty years systems for curtains intended for specialists from all over the world.

## I COLORI

Nippo è disponibile di serie nelle seguenti varianti colori: cromato e anodizzato argento satinato. È disponibile, su richiesta, con colorazioni speciali.

## COLOURS

Nippo is, as a standard, available in the following colours: chromed and silver anodized. It is available, on demand, in special colours.



NIPPO 645

# FUTURA

Futura è la linea di prodotti Mottura specificatamente rivolta all'interior design di alta gamma. È la nuova frontiera, un'interpretazione del prodotto che è la realizzazione della nostra mission "tecnologia e creatività". Una linea di prodotto, caratterizzata da un design italiano al 100% concepita con estrema attenzione all'aspetto estetico ma affiancata dal valore aggiunto di sempre di Mottura e cioè la capacità di sviluppare prodotti tecnologici di alta qualità le cui prestazioni sono indiscutibili.

Oriente e Nippo sono prodotti presenti in questa gamma di alta qualità e sono offerti in una serie speciale in cui tutti i dettagli sono realizzati in materiali pregiati e con rifiniture di qualità superiore.

Futura is the range Mottura specifically directed to the upper level interior design. Is the new frontier, a decorative interpretation of the product which is the results of our mission "technology and creativity". The product line, characterized by a 100% italian design, designed with extreme attention to aesthetic aspect but flanked by added value, as usual, of Mottura and that is the capacity to develop high technology products with a perfect performance.

Oriente and Nippo are systems available in this range of high quality and are offered in a special series in which all the details are made of precious materials and with superior finishing.

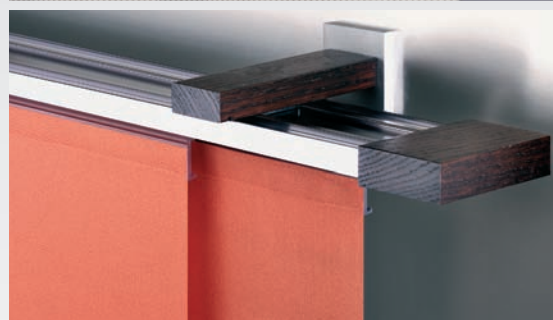

## PORTATELO CURTAIN PROFILES

**Art. 520** - è il sistema in alluminio velcrato di serie di tutta la gamma Oriente e può essere richiesto anche per la gamma Nippo. È il profilo di serie nei sistemi curvati Oriente e Nippo.

**Ref. 520** - it is the standard aluminium system with Velcro of the Oriente range, it is, on demand, available for the Nippo range too. It is the sole choice for bended systems.



**Art. 4337** - è il sistema in pvc trasparente con velcro di serie per la gamma Nippo e, su richiesta per Oriente con azionamento manuale e motorizzato.

**Ref. 4337** - it is the standard transparent PVC system with Velcro for Nippo range, on demand for Oriente hand drawn, cord or motor operating.



**Art. 540** - è il sistema in alluminio con velcro su richiesta per Oriente con azionamento manuale ed a corde.

**Ref. 540** - it is an aluminium system with Velcro available, on demand for Oriente range.

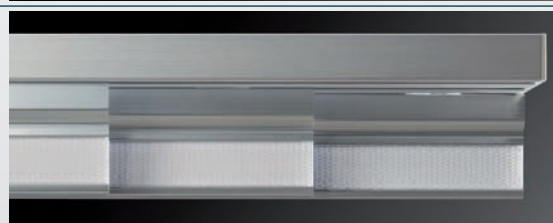

**Art. 561** - è un sistema in alluminio "a vista" su richiesta per Oriente con azionamento manuale o a corde.

**Ref. 561** - it is an "at sight" aluminium system for Oriente hand drawn, cord or motor operating.

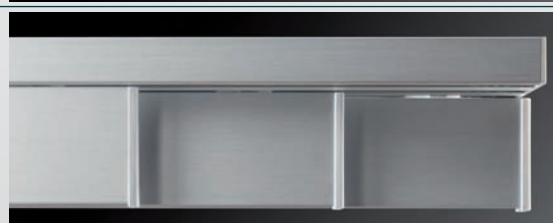

## Curve ad ampio raggio.

Large radius bends.

Oriente e Nippo sono sistemi curvabili ad ampio raggio. Da sempre la curvabilità è una delle caratteristiche prioritarie dei sistemi per tende in alluminio Mottura ed anche Oriente e Nippo rispondono a questa esigenza.

Per tutti i sistemi Oriente e Nippo il raggio minimo di curvatura è 200 cm. L'azionamento dei sistemi curvi ad ampio raggio può essere manuale ed a motore per Oriente, esclusivamente manuale per Nippo.

Oriente and Nippo are continuous radius bendable systems. As always, the ability to be curved is one of priority characteristics of Mottura aluminium systems for curtains and also Oriente and Nippo respond to this need.

Concerning Oriente and Nippo whole range, the minimum radius of curvature is 200 cm. Operating of large radius bended systems can be manual and motorized for Oriente, exclusively manual for Nippo.

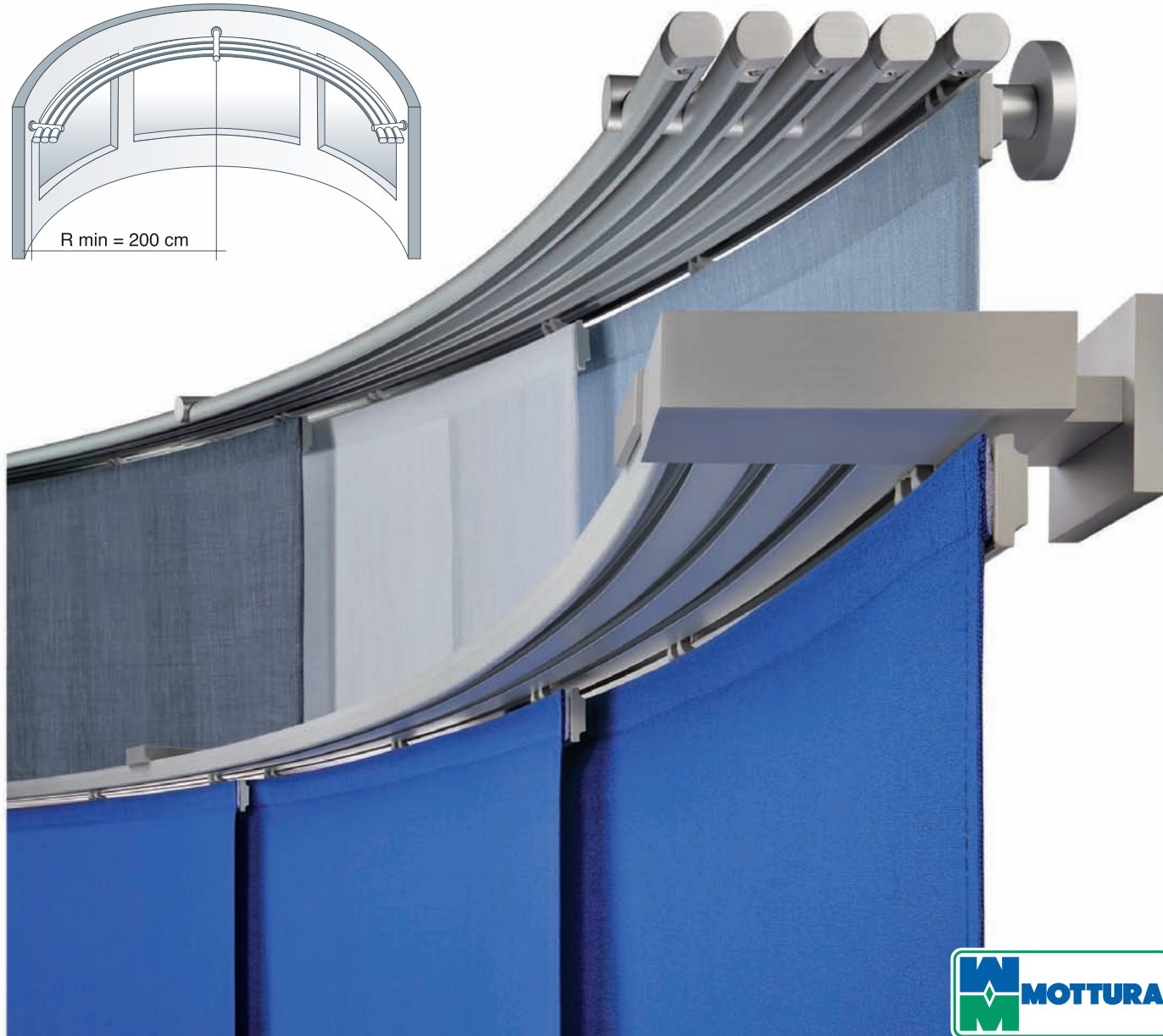
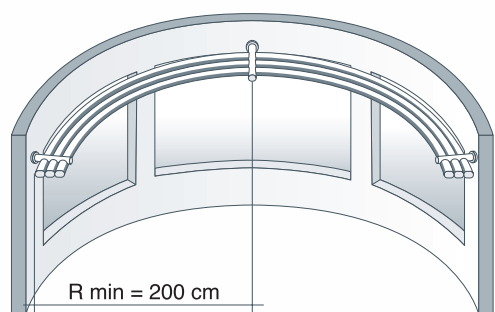

# AZIONAMENTI SOLUTIONS

 PANNELLO FISSO - STATIONARY PANEL

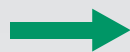

PANNELLO DI COMANDO - CORD-OPERATED PANEL

 PANNELLO TRAINATO - DRAWN PANEL

	Oriente 542 2 CANALI - 2 CHANNELS		Oriente 543 3 CANALI - 3 CHANNELS	
	CHIUSO/CLOSED	APERTO/OPEN	CHIUSO/CLOSED	APERTO/OPEN
2 TELI / PANELS			-	-
3 TELI / PANELS	-	-		
4 TELI / PANELS				
5 TELI / PANELS				
5 TELI / PANELS 2 AZIONAMENTI / OPERATIONS	-	-	-	-
6 TELI / PANELS				
6 TELI / PANELS 2 AZIONAMENTI / OPERATIONS	-	-	-	-
7 TELI / PANELS				
7 TELI / PANELS 2 AZIONAMENTI / OPERATIONS	-	-	-	-
8 TELI / PANELS	-	-		

SOLO PER PANNELLI GUIDATI CON CORDE O CON ASTA DI MANOVRA - ONLY FOR PANELS MOVED BY CORDS OR BY ROD

# AZIONAMENTI SOLUTIONS







 PANNELLO FISSO - STATIONARY PANEL

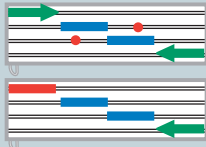
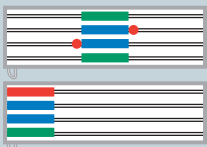
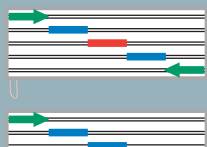

PANNELLO DI COMANDO - CORD-OPERATED PANEL

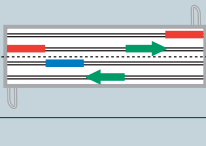
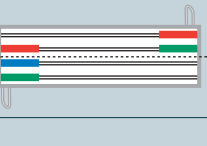
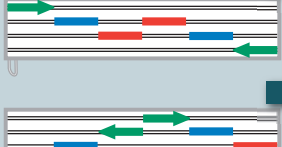
 PANNELLO TRAINATO - DRAWN PANEL

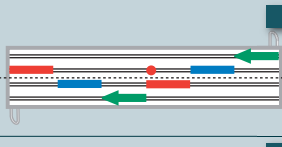
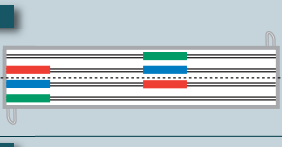
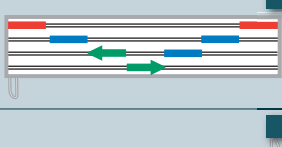
 **ART./REF. 4211:** ARRESTO TENDA - STOP SCREW

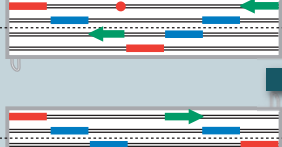
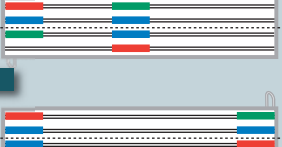
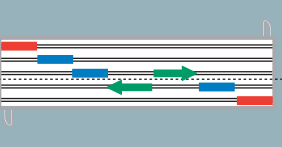
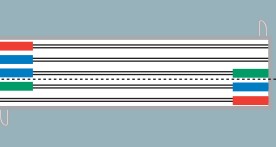
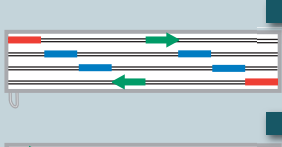
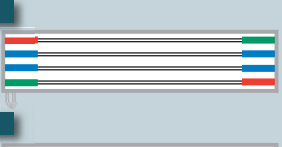
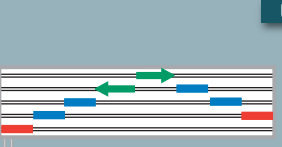
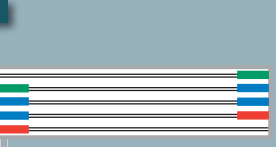
	Oriente 544 4 CANALI - 4 CHANNELS		Oriente 545 5 CANALI - 5 CHANNELS	
	CHIUSO/CLOSED	APERTO/OPEN	CHIUSO/CLOSED	APERTO/OPEN
2 TELI / PANELS	-	-	-	-
3 TELI / PANELS	-	-	-	-
4 TELI / PANELS	 <b>E</b> 		-	-
5 TELI / PANELS	-	-	 <b>G</b> 	
5 TELI / PANELS 2 AZIONAMENTI / OPERATIONS	 <b>I</b> 		-	-
6 TELI / PANELS	 <b>M</b> 		-	-
6 TELI / PANELS 2 AZIONAMENTI / OPERATIONS	 <b>O</b> 		-	-
7 TELI / PANELS	 <b>Q</b> 		-	-
7 TELI / PANELS 2 AZIONAMENTI / OPERATIONS	 <b>S</b> 		 <b>S</b> 	
8 TELI / PANELS	 <b>U</b> 		 <b>U</b> 	

SOLO PER PANNELLI GUIDATI CON CORDE O CON ASTA DI MANOVRA - ONLY FOR PANELS MOVED BY CORDS OR BY ROD



### INSTALLAZIONE A PARETE WALL INSTALLATION

### INSTALLAZIONE A SOFFITTO CEILING INSTALLATION

#### ORIENTE

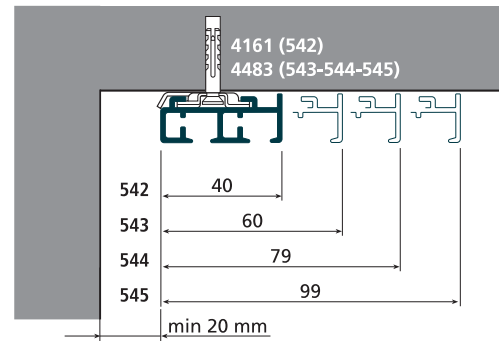
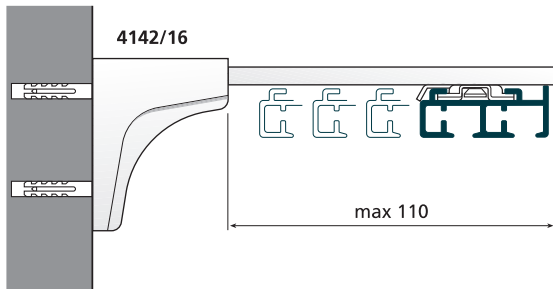

#### NIPPO

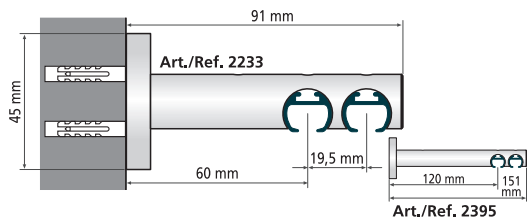

SUPPORTO 2 CANALI / 2 WAYS SUPPORT

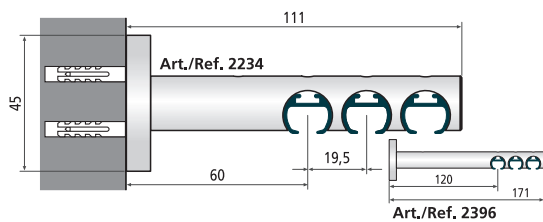

SUPPORTO 3 CANALI / 3 WAYS SUPPORT

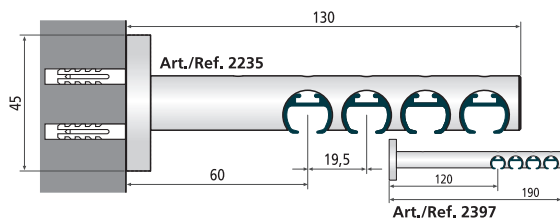

SUPPORTO 4 CANALI / 4 WAYS SUPPORT

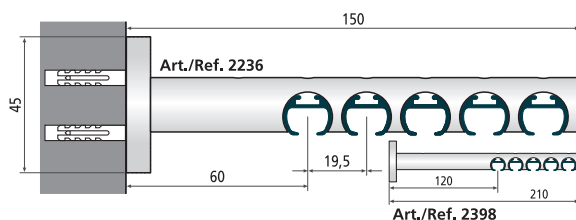

SUPPORTO 5 CANALI / 5 WAYS SUPPORT

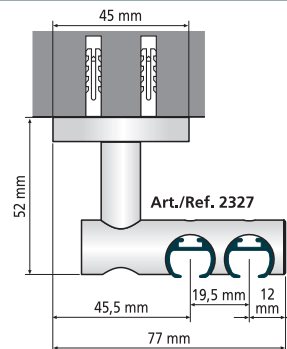

SUPPORTO 2 CANALI /  
2 WAYS SUPPORT

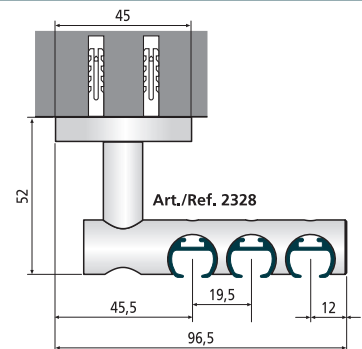

SUPPORTO 3 CANALI /  
3 WAYS SUPPORT

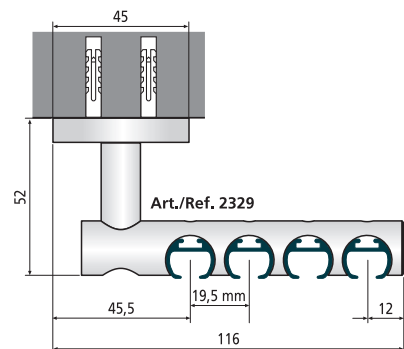

SUPPORTO 4 CANALI / 4 WAYS SUPPORT

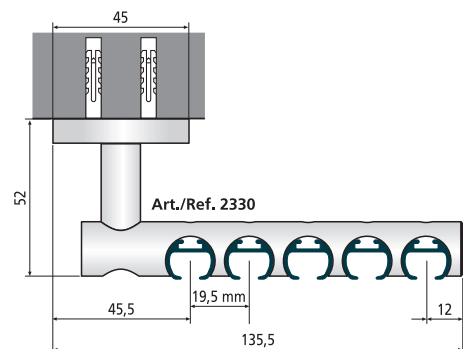

SUPPORTO 5 CANALI / 5 WAYS SUPPORT